

Temposonics®

Absolute, Non-Contact Position Sensors

R-Series Profibus

Temposonics® RP and RH
Measuring length 25 - 7600 mm



**Advanced Communication
... offers Multi-Position Measurement**

- Rugged Industrial Sensor
- Linear and Absolute Measurement
- LEDs for Sensor Diagnostics
- Non-contact Sensing with Highest Durability
- Superior Accuracy: Linearity better 0,01 %
- Resolution up to 1 μm
- Repeatability 0,001 %
- Direct Profibus-DP Output, Displacement + Speed
- Multi-Position Measurement: 1 Sensor for max. 20 Positions

Sensor Diagnostic Display

Integrated LEDs (green/red) provide basic visual feedback for normal sensor operation and troubleshooting.



Green	Red	Description
ON	OFF	Normal function
ON	ON	Magnet not detected or Wrong quantity of magnets
Flashing	OFF	Waiting for Master parameters
Flashing	ON	Programming mode

Profibus Interface

Temposonics® sensors fulfill all requirements of PROFIBUS-DP (EN 50170). The sensor realizes the absolute position measuring with direct transmission of serial, bitsynchronous data in RS485 standard to control units in a baud rate of 12 Mbit/s maximum. PROFIBUS interface is built-up with Siemens buscontroller SPC3. In addition to applications data transmission, PROFIBUS provides powerful functions for diagnostics and configuration, loaded into the bus via the GSD (Electronic Device Data Sheet). Profibus sensors - corresponding DP-slave Class 2 - featuring

Sensor Outputs:

- Absolute position measurement
- Speed measurement
- Sensor status
- Error detection (e.g. magnet status)

Selectable Parameters:

- Offset/Preset for each magnet
- Measuring direction: Forward/reverse
- Resolution
- Different data formats

Operation Mode:

P101 1-20 Multi-Magnet measurement

Position measurement of max. 20 magnets simultaneously

P102 1 Magnet measurement (Standard)

Positions measurement 1 magnet

P103 1-5 Multi-Magnet measurement

Position and speed measurement of max. 5 magnets simultaneously

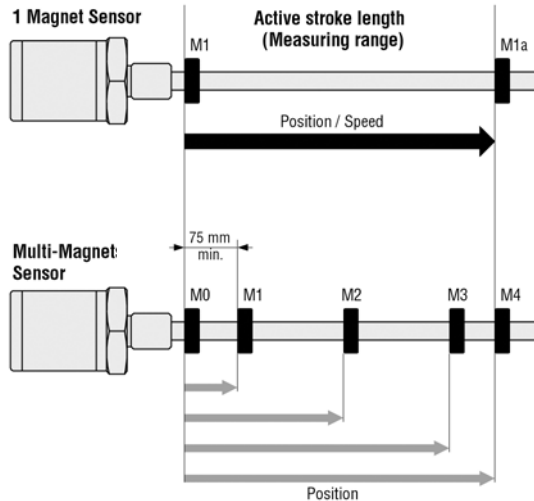

Data Exchange

With Multi-Magnet measurement, 1 status byte and 3 bytes of position data for each position are transmitted. The status byte contains e.g. the error bit and the position number of the following measurement value. Dependent on sensor parameters setting, the position data can be transferred to the control unit in different formats (e.g. INTEL or MOTOROLA format).

Accessory: MTS Servicetool

Profibus Address-Programmer is used for setup sensor's slave address. Normally addressing is done by Profibus **SetSlaveAddress**. Since some master systems do not support this standard, or customers controller can not handle, this tool - connected to the sensor - can be used for direct addressing.

Technical Data
Input

Measured variable	Displacement / Option: Multi-Magnet measurement (max. 20 positions or 5 positions + 5 velocities)
Measuring length	Profile 25 - 5000 mm / Rod 25 - 7600 mm

Output

Output signal	PROFIBUS-DP System according ISO 74498
Data format	PROFIBUS-DP (EN 50 170)
Data transmission rate	Max. 12 Mbit/s

Accuracy

Resolution	
- Displacement	1 µm / other values selectable via GSD-File
- Speed	5 µm displacement resolution: 0,64 mm/s up to 500 mm; 0,43 mm/s up to 2000 mm; 0,21 mm/s up to 4500 mm; 0,14 mm/s up to 7600 mm stroke length
Linearity	< ± 0,01 % F.S. (Minimum ± 50 µm) Option internal linearisation Linearity tolerance: RP/RH < 300 mm: typ. ± 15 µm, max. ± 25 µm, > 300 ... 600 mm: typ. ± 20 µm, max. ± 30 µm > 600 ... 1200 mm: typ. ± 30 µm, max. ± 50 µm RP 1200 ... 3000 mm: typ. ± 45 µm, max. ± 90 µm, 3 ... 5 m: typ. ± 85 µm, max. ± 150 µm
Option Internal Linearization	Linearity ± 20 µm ... ± 70 µm = 100 mm ... 5000 mm ML
Repeatability	< ± 0,001 % F.S. (Minimum ± 2,5 µm)
Cycle time, standard (1 magnet)	0,5 ms at 500 mm / 1 ms at 2000 mm / 2 ms at 4500 mm / 3,1 ms at 7600 mm stroke length each additional magnet + 0,05 ms; for speed measurement ca. + 0,03 ms
Temperature coefficient	< 15 ppm/°C
Ripple	< 5 µm
Hysteresis	< 4 µm

Operating conditions

Magnet speed	any
Operating temperature	-40 °C ... +75 °C
Dew point, humidity	90% rel. humidity, no condensation
Protection	Profile: IP65, Rod: IP67, if mating connector is correctly fitted, RS: IP69K
Shock test	100 g single hit, IEC-Standard 68-2-27
Vibration test	15 g / 10 - 2000 Hz, IEC-Standard 68-2-6
Standards, EMC test	Electromagnetic emission EN 61000-6-4, CISPR 16 Electromagnetic immunity EN 61000-6-2 EN 61000-4-2/3/4/6, Level 3/4, Criterium A, CE-qualified

Design, material

Diagnostic display	LEDs beside connector
Profile model:	
Sensor head	Aluminum
Sensor stroke	Aluminum
Position magnet	Magnet slider or removable U-magnet
Rod model:	
Sensor head	Aluminum
Rod with flange	Stainless steel 1.4301 / AISI 304
Pressure rating	350 bar, 700 bar peak
Position magnet	Ring magnets, U-magnets

Installation

Mounting position	any orientation
Profile	Movable mounting clamps or T-slot nuts M5 in base channel
U-Magnet, removable	Mounting plate and screws from antimagnetical material
Rod	Threaded flange M18 x 1,5 or 3/4" -16 UNF-3A, Hex nut M18
Position magnet	Mounting plate and screws from antimagnetical material

Electrical connection

Connection type	2 x 6 pin connector M16 or 2 x 5 pin connector M12 + 4 pin, connector M8 Cable outlet 2 x 0 - 10 m PUR-cable + 4 pin, connector M8
Input voltage	24 VDC (-15 / +20 %)
- Polarity protection	up to -30 VDC
- Overvoltage protection	up to 36 VDC
Current drain	90 mA typical
Ripple	< 1 % S-S
Electric strength	500 VDC (DC ground to machine ground)

Stable Profile Design

Temposonics®-RP offers modular construction, flexible mounting configurations and easy installation. Position measurement is contactless via two versions of permanent magnets.

- A sliding magnet running in profile housing rails. Connection with the mobile machine part is via a ball jointed arm to taking up axial forces.
- A floating magnet, mounted directly on the moving machine part, travels over the profile at a low distance. Its air-gap allows the correction of small misalignments at installation.

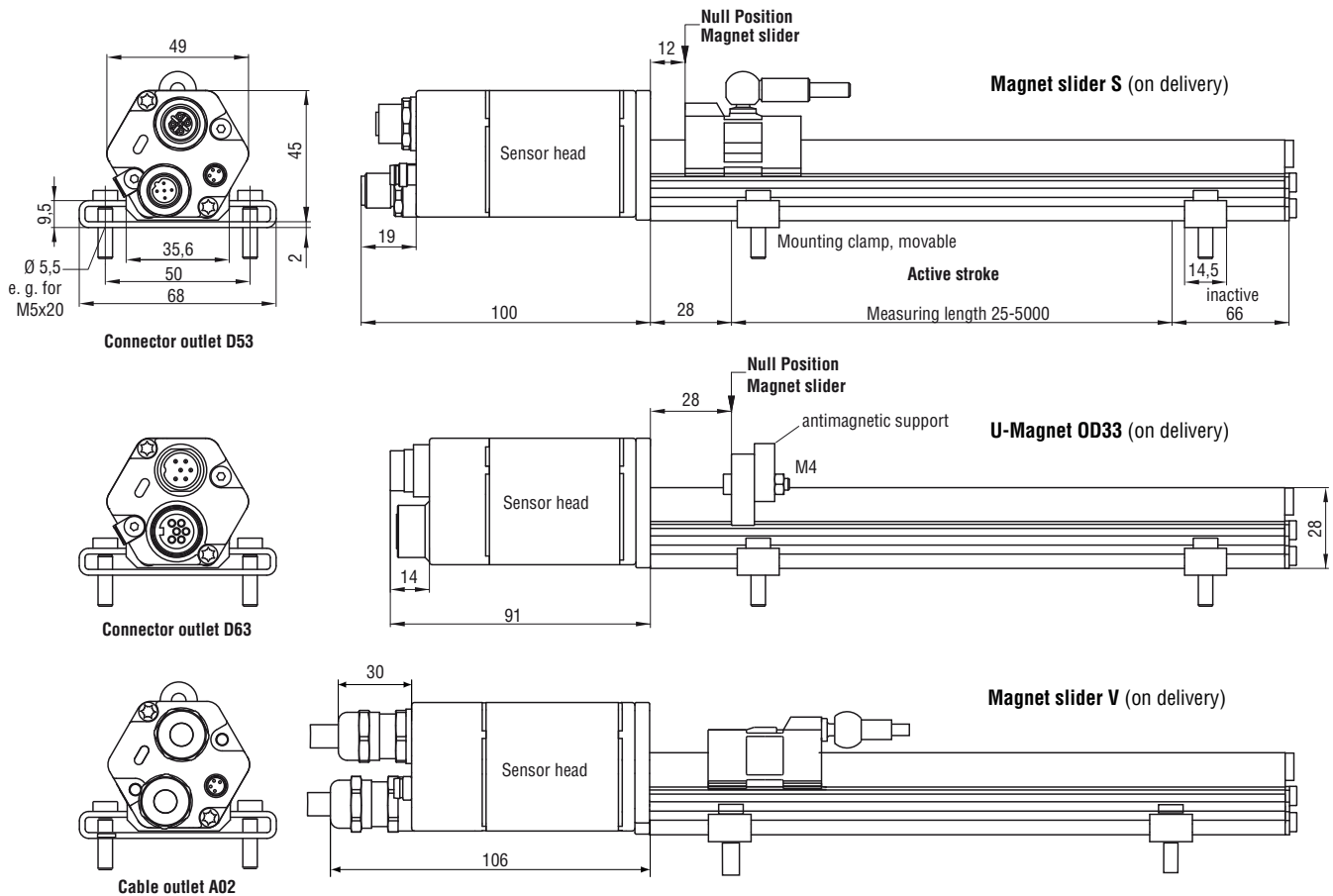

Wiring D63

Pin	Cable	Function
1	green	RxD/TxD-N (Bus)
2	red	RxD/TxD-P (Bus)
3	---	DGND (Bus termination)*
4	---	VP (Bus termination)*
5	black	+24 VDC (-15/+20 %)
6	blue	DC Ground (0V)
-	yellow/green	do not connect

*female only

Wiring D53 Bus connector

Pin	Cable	Function
1	---	VP+5 (Bus termination)*
2	green	RxD/TxD-N (Bus)
3	---	DGND (Bus termination)*
4	red	RxD/TxD-P (Bus)
5	shield	shield

*female only

Input voltage

Pin	Cable	Function
1	brown	+24 VDC (-15/+20 %)
2	white	do not connect
3	blue	0 V (GND)
4	black	do not connect

All dimensions in mm

Standard position magnet upon delivery (see chapter Accessories)

Position magnets

- Magnet slider S (Part No. 252 182)
- Magnet slider V (Part No. 252 184)
- U-Magnet OD33 (Part No. 251 416-2)

Connection types

- 5 pin female connector M12-B (Part No. 560 885)
- 5 pin male connector M12-B (Part No. 560 884)
- 4 pin cable connector M8, 90° (Part No. 560 886)

High Pressure Rod Design

Temposonics®-RH with a pressure-resistant stainless steel flange and sensing rod is suitable for use in hydraulic cylinders and externally in all applications where space is a problem. Position measurement is via ring or U-magnets travelling along the sensing rod without any mechanical contact.

Advantage...

the completely operable sensor cartridge can be replaced for servicing easily without opening the fluid circuit.

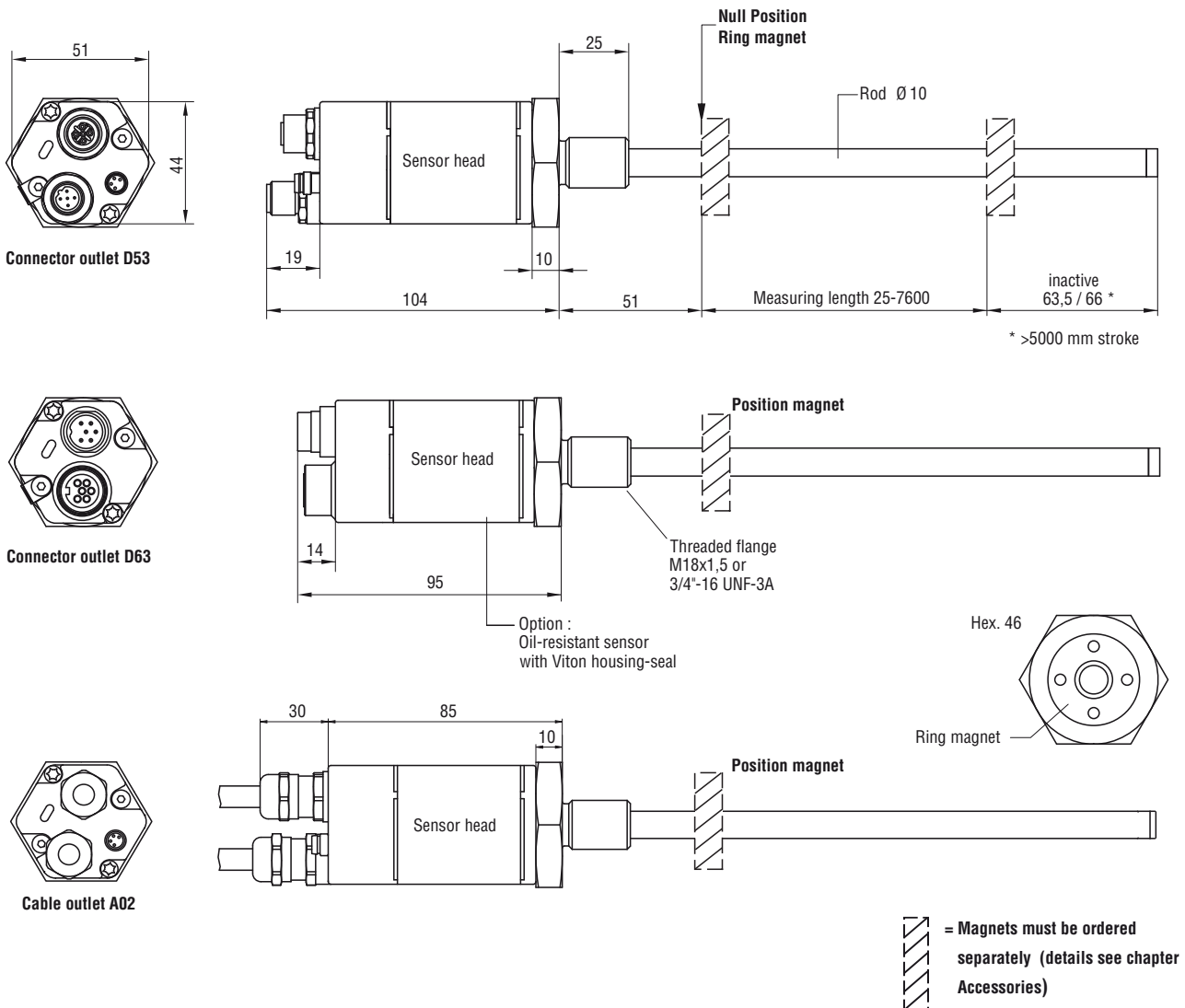

Standard Position Magnets (not on delivery, please order separately)

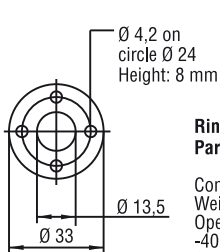

Ring magnet OD33
Part No. 201 542-2

Composite PA-Ferrite-GF20
Weight ca. 14 g
Operating temperature: -40 ... +100°C
Surface pressure max. 40 N/mm²
Fastening Torque for M4 screws max. 1 Nm

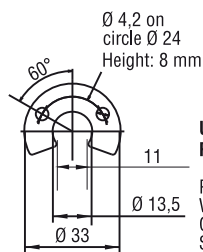

U-Magnet OD33
Part No. 251 416-2

PA-Ferrit-GF20
Weight ca. 11 g
Operating temperature: -40 ... +100°C
Surface pressure max. 40 N/mm²
Fastening torque for M4 screws max. 1 Nm

All dimensions in mm

Standard position magnet not on delivery (see chapter Accessories)

Position magnets

Ring magnet OD33 (Part No. 201 542-2)
Ring magnet OD25,4 (Part No. 400 533)
U-Magnet OD33 (Part No. 251 416-2)

Connection types

5 pin female connector M12-B (Part No. 560 885)
5 pin male connector M12-B (Part No. 560 884)
4 pin cable connector M8, 90° (Part No. 560 886)

Temposonics® **M** **P** **Z**

Sensor model

RP - Profile
RH - Rod

Design

Profile Temposonics®-RP:

S - Magnet slider, joint at top
V - Magnet slider, joint at front
G - Magnet slider, joint at top, backlash free
M - U-Magnet, OD33

Rod Temposonics®-RH:

M - Flange M18 x 1,5 (Standard)
V - Flange M18 x 1,5 (Fluorelastomer housing-seal)
D - Flange M18 x 1,5 with bushing on rod end
R - Flange M18 x 1,5 with thread M4 at rod end
J - Flange M22 x 1,5, rod Ø 12,7 mm, 800 bar
S - Flange 3/4" - 16 UNF - 3A

Measuring length

Profile - 0025...5000 mm
Rod - 0025...7600 mm
Standard: See chart
Other length upon request.

Connection type

D63 - 2 x 6 pin male/female receptacle M16
D53 - 2 x 5 pin male/female receptacle M12, 4 pin male receptacle M8
A02 - 2 m PUR-cable w/o connector, option: A01-A10 (1-10 m)

Input voltage

1 - +24 VDC
A - +24 VDC, high vibration resistant (measuring length 25 ... 2000 mm)

Output

P = Profibus-DP
101 - Profibus-DP, Multi-Position measurement, 1 - 20 positions (Standard)
102 - Profibus-DP, Single-Position measurement (Standard)
103 - Profibus-DP, Singel- and Multi-Position measurement, 1-5 positions and velocity
105 - Profibus-DP, Singel- and Multi-Position measurement, 1-15 positions and velocity, intern linearization (Specified tolerances valid for Single-Position measurement)

Magnet number for Multi-Position measurement*

Z02 - Z20 = 2 - 20 pcs

* Note: Please specify magnet numbers for your sensing application and order separately

Note: Projecting and parameterizing a Profibus system will be done with servicetool of Profibus mastersystem supplier.

On delivery Profile Model:

Sensor, magnet slider or U-magnet, 2 mounting clamps up to 1250 mm stroke + 1 clamp for every additional 500 mm. Installation guide + CD-ROM (Electronic Data Sheet with standardized Device Data Base File)

On delivery Rod Model:

Sensor and O-Ring. Installation guide + CD-ROM (Electronic Data Sheet with standardized Device Data Base File)
Magnets must be ordered separately. Use signed magnets for sensors w/LCO

Stroke Length Standard RP	
Stroke Length	Ordering Steps
≤ 500 mm	25 mm
500 - 2500 mm	50 mm
2500 - 5000 mm	100 mm
> 5000 mm	250 mm

Stroke Length Standard RH	
Stroke Length	Ordering Steps
< 500 mm	5 mm
500 - 750 mm	10 mm
750 - 1000 mm	25 mm
1000-2500 mm	50 mm
2500 - 5000 mm	100 mm
> 5000 mm	250 mm

Accessories page 57 and following.

MOUNTING / INSTALLATION RP + RH

Flexible Installation in any Position

Profile Model

Normally, the sensor is firmly installed - fixed on a straight surface of the machine with movable mounting clamps or M5 screws in base channel (2 mounting clamps up to 1250 mm + 1 clamp for every 500 mm) - whilst the magnet is mounted at the mobile machine part.

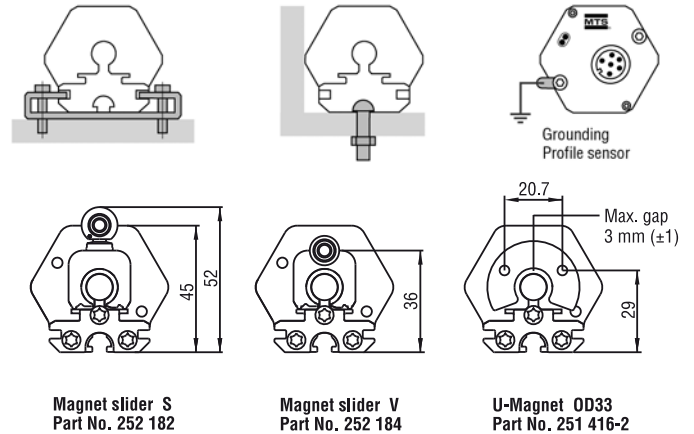

Rod Model

Mount the sensor via flange thread or a hex nut. If possible, non-magnetisable material should be used for mounting support (dimensions as shown). With horizontal mounting, longer sensors (from 1 meter) must be provided with mechanical support.

Hydraulic Sealing

Recommended is sealing of the flange facing with O-Ring (e.g. 22,4 x 2,65) in a cylinder cover nut or an O-Ring 15,3 x 2,2 in undercut.

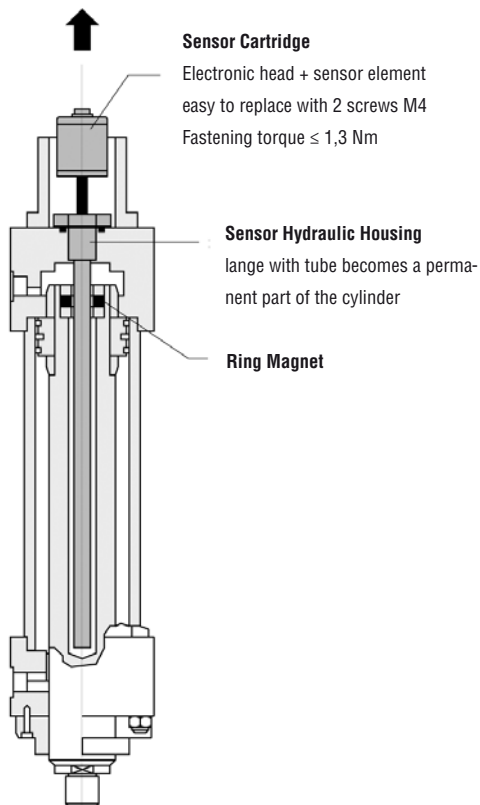

Minimum assembly distance

1. Non-magnetisable material

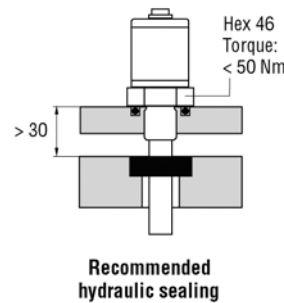

2. Magnetisable material

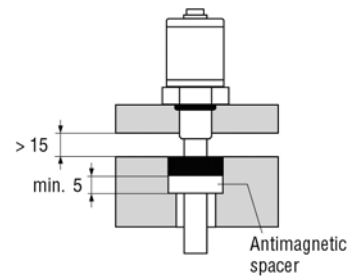

On delivery:
O-Ring 15,3 x 2,2
See ISO 6149-1

Cylinder Installation

When used for direct stroke measurement in fluid cylinders, the sensor's high pressure, stainless steel rod installs into a bore in the piston head/rod assembly as illustrated. That guarantees a longlife and trouble-free operation - independent of used hydraulic fluid.

The sensor cartridge can be removed from the flange and rod housing while still installed in the cylinder. This procedure allows quick and easy sensor cartridge replacement, without the loss of hydraulic pressure.

Temposonics®

Absolute, Non-Contact Position Sensors











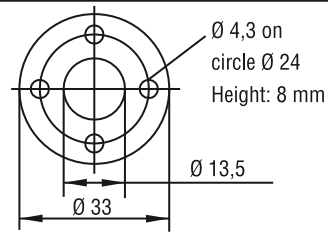

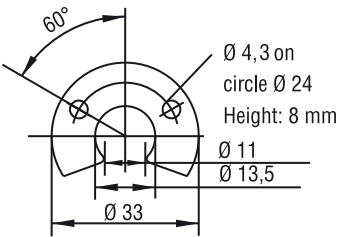
Accessories

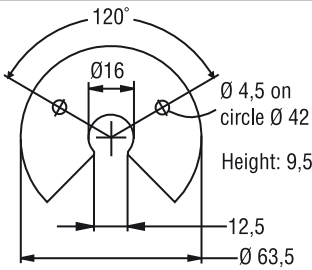

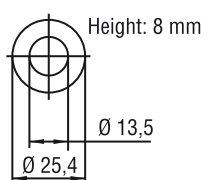
- Position Magnets
- Floats
- Connectors
- Clamps
- Cables
- Programming Tools
- High Pressure Housing, ...

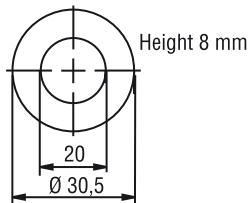
ACCESSORIES R-SERIES

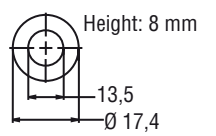

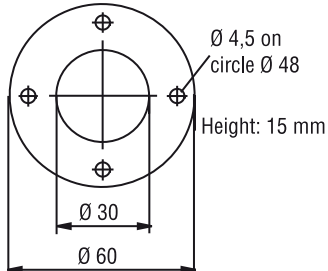







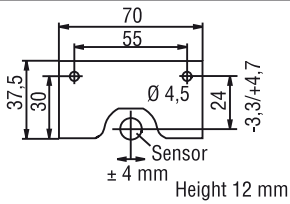

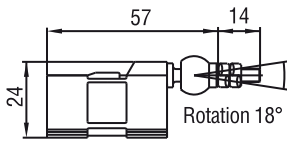

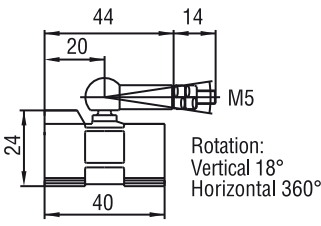
Position Magnets, Floats, Connectors, Clamps, Cables and Programming Tools

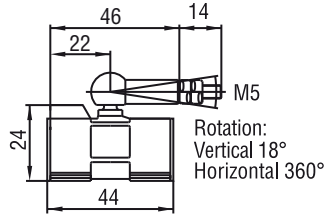
Product	Dimension	Material	Application
 <p>Standard magnet Ring magnet OD33 Part No. 201 542-2</p>	 <p>Ø 4,3 on circle Ø 24 Height: 8 mm Ø 13,5 Ø 33</p>	<p>Composite PA-Ferrite-GF20 Weight ca. 14 g Operating temperature: -40 ... +100°C Surface pressure max. 40 N/mm² Fastening Torque for M4 screws max. 1 Nm</p>	<p>RH, RF, RD4 marked version for sensors with linearity correction option (LCO): Part No. 253 620</p>
 <p>Standard magnet U-magnet OD33 Part No. 251 416-2</p>	 <p>60° Ø 4,3 on circle Ø 24 Height: 8 mm Ø 11 Ø 13,5 Ø 33</p>	<p>Composite PA-Ferrite-GF20 Weight ca. 11 g Operating temperature: -40 ... +100°C Surface pressure max. 40 N/mm²</p>	<p>RH, RF, RP marked version for sensors with linearity correction option (LCO): Part No. 254 226</p>
 <p>U-magnet OD63,5 Part No. 201 553</p>	 <p>120° Ø 16 Ø 4,5 on circle Ø 42 Height: 9,5 12,5 Ø 63,5</p>	<p>PA 66-GF30 Magnets compound-filled Weight ca. 26 g Operating temperature: -40 ... +75°C</p>	<p>RH, RF, RP</p>
 <p>Ring magnet OD25,4 Part No. 400 533</p>	 <p>Height: 8 mm Ø 13,5 Ø 25,4</p>	<p>Composite: PA-Ferrite Weight ca. 10 g Operating temperature: -40 ... +100°C Surface pressure max. 40 N/mm²</p>	<p>RH, RF, RD4 marked version for sensors with linearity correction option (LCO): Part No. 253 621</p>
 <p>Ring magnet OD30,5 Part No. 402 316</p>	 <p>Height 8 mm 20 Ø 30,5</p>	<p>Composite: PA-Ferrite Weight ca. 15 g Operating temperature: -40 ... +100°C Surface pressure max. 40 N/mm²</p>	<p>RH, RF, RD4</p>
 <p>Ring magnet Part No. 401 032</p>	 <p>Height: 8 mm 13,5 Ø 17,4</p>	<p>PA-Neonbond compound Weight ca. 5 g Operating temperature: -40 ... +100 Surface Pressure max. 20 N/mm²</p>	<p>RH, RD4 (not for multi-position measurement)</p>
 <p>Ring magnet OD60 Part No. MT 0162</p>	 <p>Ø 4,5 on circle Ø 48 Height: 15 mm Ø 30 Ø 60</p>	<p>Al CuMgPb Magnets compound-filled Weight ca. 90 g Operating temperature: -40 ... +75°C</p>	<p>RH, RF, RD4</p>

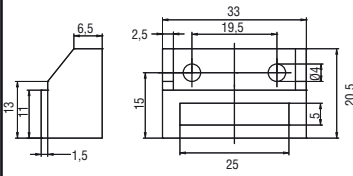
Notice: More magnets available on request. Product pictures may vary from original.

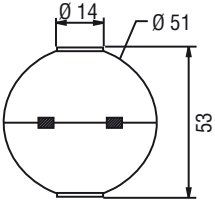
ACCESSORIES R-SERIES

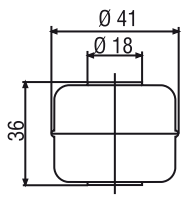

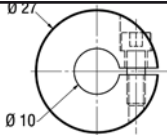







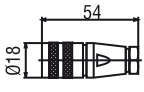

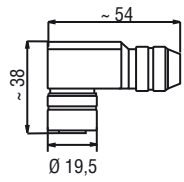
Position Magnets, Floats, Connectors, Clamps, Cables and Programming Tools

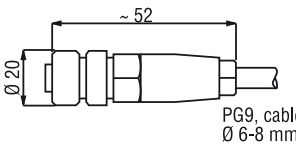
Product	Dimension	Material	Application
 <p>U-magnet 70 Part No. 252 185</p>	 <p>Sensor ± 4 mm Height 12 mm</p>	<p>AlMg4.5Mn, black anodised Magnets compound-filled Weight ca. 75 g Operating temperature: -40...+75°C</p>	<p>RH, RF, RP Resolution min. 10 µm</p>
 <p>Magnet slider V Part No. 252 184</p>	 <p>Rotation 18°</p>	<p>GFK, Magnet Hardferrite Weight ca. 30 g Operating temperature: -40 ... +75°C</p>	<p>RP</p>
 <p>Magnet slider S Magnet slider G Part No. 252 182 Part No. 253 421</p>	 <p>Rotation: Vertical 18° Horizontal 360°</p>	<p>GFK, Magnet Hardferrite Weight ca. 30 g Operating temperature: -40 ... +75°C Magnet slider S: Ball joint CuZn 39Pb3 nickel plated Magnet slider G - free from float: Socket joint, high-strength plastics Ball joint CuZn39Pb3 nickel plated</p>	<p>RP</p>
 <p>Magnet slider P Part No. 253 673</p>	 <p>Rotation: Vertical 18° Horizontal 360°</p>	<p>GFK, Magnet Hardferrite Weight ca. 30 g Operating temperature: -40 ... +75°C with additional end plates</p>	<p>RP</p>
 <p>Block magnet Part No. 403 448</p>		<p>Weight: ca. 20 g Operating temperature: -40...+75°C</p>	<p>RH, RF, RP Resolution min. 10 µm</p>
 <p>Float 50 mm Part No. 251 447</p>		<p>1.4571 Stainless steel Density: 720 kg/m³ Max. Pressure: < 40 bar Weight: 42 ± 3 g</p>	<p>RH, RF</p>
 <p>Float 41 mm Part No. 200 938-2</p>		<p>1.4404 Stainless steel Density: 740 kg/m³ Max. Pressure: =< 8 bar Weight: 20 ± 2 g</p>	<p>RH, RF</p>
 <p>Collar Part No. 560 777</p>		<p>1.4301 Stainless steel</p>	<p>RH</p>

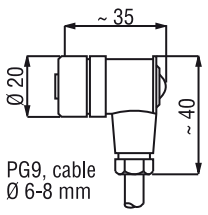
Notice: Product pictures may vary from original.

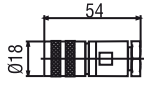
ACCESSORIES R-SERIES

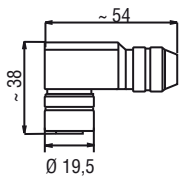

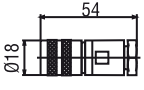







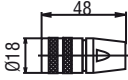

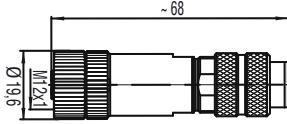
Position Magnets, Floats, Connectors, Clamps, Cables and Programming Tools

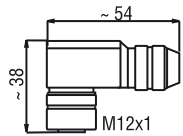
Product	Dimension	Material	Application
 <p>6 pin Connector (for cable Ø 6 mm) Part No. 370 623 (female) For cable Ø 6-8 mm Part No. 370 423</p>		Housing: Zinc nickel plated Termination: Solder Contact insert: Silver plated Max. Cable-Ø 6 mm or Ø 8 mm depending on design	Analog CAN
 <p>6 pin Connector M16, 90° Part No. 560 778 (female)</p>		Housing: Zinc nickel plated Termination: Solder Contact insert: Silver plated Max. Cable-Ø 8 mm	Analog CAN
 <p>5 pin connector, M12x1 Part No. 370 618 (female)</p>		Housing: PA Termination: Screws clamp Contact insert: (CuZn/Sn) Max. Cable-Ø 6-8 mm	CAN
 <p>5 pin connector, M12x1, 90° Part No. 370 619 (female)</p>		Housing: PA Termination: Screws clamp Contact insert: (CuZn/Sn) Max. Cable-Ø 6-8 mm	CAN
 <p>7 pin Connector, M16 Part No. 370 624 (female)</p>		Housing: Zinc nickel plated Termination: Solder Contact insert: Silver plated Cable clamp: PG9 Max. Cable-Ø 8 mm	SSI
 <p>7 pin Connector, M16, 90° Part No. 560 779 (female)</p>		Housing: Zinc nickel plated Termination: Solder Contact insert: Silver plated Max. Cable-Ø 8 mm	SSI
 <p>6 pin Connector, M16 Part No. 370 423 (female) Part No. 370 427 (male)</p>		Housing: Zinc nickel plated Termination: Solder Contact insert: Silver plated Cable clamp: PG9	Profibus (D63)

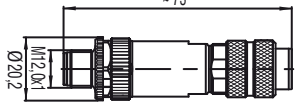
Notice: Product pictures may vary from original.

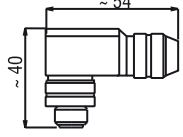
ACCESSORIES R-SERIES

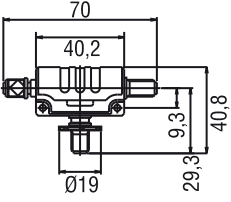

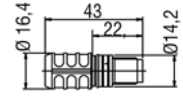







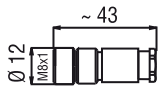

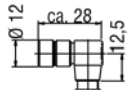
Position Magnets, Floats, Connectors, Clamps, Cables and Programming Tools

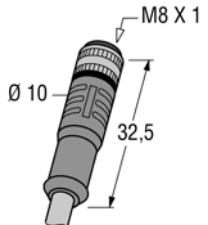
Product	Dimension	Material	Application
 <p>6 pin Bus endplug M16, male Part No. 370 620</p>		<p>Housing: Zinc nickel plated Contact insert: Silver plated</p>	Profibus (D63)
 <p>5 pin connector M12-B Part No. 560 885 (female)</p>		<p>Housing: Zinc nickel plated Termination: spring-type terminal Contact insert: Silver plated Cable-Ø: 6,5 - 8,5 mm</p>	Profibus (D53)
 <p>5 pin 90° connector M12-B Part No. 370 514 (female)</p>		<p>Housing: Zinc nickel plated Termination: spring-type terminal Contact insert: Silver plated Cable-Ø: 6,5 - 8,5 mm</p>	Profibus (D53)
 <p>5 pin connector M12-B Part No. 560 884 (male)</p>		<p>Housing: Zinc nickel plated Termination: Srews clamp Contact insert: Silver plated Cable-Ø: 6,5 - 8,5 mm</p>	Profibus (D53)
 <p>5 pin 90° connector M12-B Part No. 370 515 (male)</p>		<p>Housing: Zinc nickel plated Termination: Srews clamp Contact insert: Silver plated Cable clamp: M16 Cable-Ø: 6,5 - 8,5 mm Cable type e.g.: K25</p>	Profibus (D53)
 <p>5 pin Bus T-connector M12 Part No. 560 887</p>		<p>Housing: PA 66 Contact insert: Silver plated</p>	Profibus (D53)
 <p>5 pin Bus endplug M12 Part No. 560 888</p>		<p>Housing: PA 66 Contact insert: Silver plated</p>	Profibus (D53)

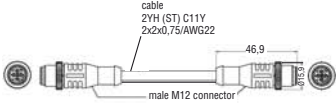
Notice: Product pictures may vary from original.

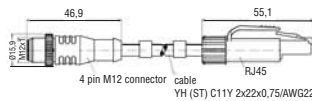
ACCESSORIES R-SERIES

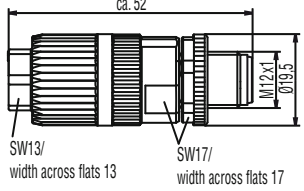









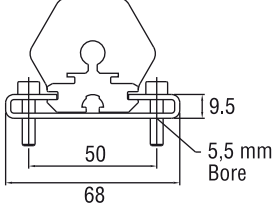

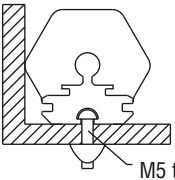
Position Magnets, Floats, Connectors, Clamps, Cables and Programming Tools

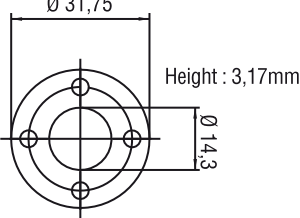
Product	Dimension	Material	Application
 <p>4 pin cable connector M8 Part No. 370 504</p>	 <p>~ 43 Ø 12</p>	<p>Housing: Brass nickel plated Termination: Solder Contact insert: Au Max. Cable-Ø 5 mm</p>	<p>Profibus (D53) EtherCAT CAN (D54)</p>
 <p>4 pin cable connector M8, 90° Part No. 560 886</p>	 <p>Ø 12 ca. 28 12,5</p>	<p>Housing: PA 66 Termination: Solder Contact insert: Au Max. Cable-Ø 5 mm</p>	<p>Profibus (D53) EtherCAT CAN (D54)</p>
 <p>Cable connector Part No. 530 066 Part No. 530 096 Part No. 530 093</p>	 <p>M8 X 1 Ø 10 32,5</p>	<p>PUR-cable with 4 pin. female connector 5 m length free end 4 x 0,25 mm², shielded for 24 V power supply</p> <p>Part No. 530 066 = 5 m length Part No. 530 096 = 10 m length Part No. 530 093 = 15 m length</p>	<p>Profibus (D53) EtherCAT CAN (D54)</p>
 <p>Cable connector Part No. 530 064</p>	 <p>46,9 male M12 connector cable 2YH (ST) C11Y 2x2x0,75/AWG22</p>	<p>5 m industrial Ethernet cable (Cat 5e ES) w/2x4 pin M12-connectors (D-coded) PUR-jacket, green</p>	<p>EtherCAT</p>
 <p>Cable connector Part No. 530 065</p>	 <p>46,9 55,1 4 pin M12 connector cable YH (ST) C11Y 2x2x0,75/AWG22 RJ45</p>	<p>5 m industrial Ethernet cable (Cat 5e ES) RJ45 connector and M12-connector (D-coded) PUR-jacket, green</p>	<p>EtherCAT</p>
 <p>4 pin Bus cable connector Part No. 370 523</p>	 <p>ca. 52 M12 x1 Ø 19,5 SW13/ width across flats 13 SW17/ width across flats 17</p>	<p>IDC technology</p>	<p>EtherCAT</p>
 <p>End cap Part No. 370 537</p>		<p>Aluminum</p>	<p>EtherCAT</p>

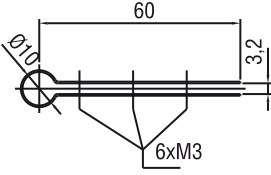
Notice: Product pictures may vary from original.

ACCESSORIES R-SERIES

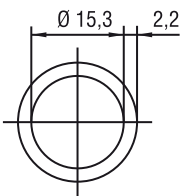
Position Magnets, Floats, Connectors, Clamps, Cables and Programming Tools

Product	Dimension	Material	Application
 Clamp Part No. 400 802	 9.5 50 68 5,5 mm Bore	Stainless steel	RP
 T-Nut Part No. 401 602	 M5 thread	Stainless steel	RP
 Spacer Part No. 400 633	 Ø 31,75 Height : 3,17mm Ø 14,3	Aluminum	RH
 Fixing clip Part No. MT 0200	 60 2,5 Ø10 6xM3	Brass Flat section and fastening screws: non-magnetic material	RH
 Metal protection cap for connector M16 Part No. 403 290			Analog, CAN, SSI, Profibus
 Hex nut Part No. 500 018		Edelstahl	RH-M
 O-ring Part No. 401 133	 Ø 15,3 2,2	Fluorelastomer FPM 75 Operating temperature: -10...+125°C	RH-M
 Cable Part No. 530 032	3 x 2 x 0,14 mm ² Ø 6 mm	PVC -10 ... +80°C	Standard

Notice: Product pictures may vary from original.

ACCESSORIES R-SERIES





Position Magnets, Floats, Connectors, Clamps, Cables and Programming Tools

Product	Dimension	Material	Application
 Cable Part No. 530 052	3 x 2 x 0,25 mm Ø 6,8 mm	Pelon PUR -40 ... +80°C	Halogen free Oil-resistant High flexible
 Cable Part No. 530 116	4 x 2 x 0,25 mm²	PUR (-30 ... +90°C)	Water proof wires
 Cable Part No. 530 112	4 x 2 x 0,25 mm²	Teflon (-90 ... +180°C)	Temperature
 Cable Part No. 530 029	7 x 0,14 mm² EMC protected Ø 7 mm	PUR -20 ... +70°C	SSI, CAN
 Cable Part No. 530 040	BUS + feed-in Ø 8 mm	PVC -30 ... +80°C	Profibus-DP D63
 Cable Part No. 530 109	BUS conductor, high flexible cable Ø 8 mm	PUR -30 ... +70°C	Profibus-DP D53
Product	Description		
 Hand-Programmer R-Analog Part No. 253 124	Hand-Programmer R-Analog for 1-Magnet Sensor is for easy teach-in-setups of measuring length and direction on desired Zero/Span positions.		

Notice: Product pictures may vary from original.

ACCESSORIES R-SERIES



Position Magnets, Floats, Connectors, Clamps, Cables and Programming Tools

Product	Description
 <p>Cabinet-Programmer Part No. 253 408</p>	<p>Cabinet-Programmer R-Analog Cabinet-Programmer R-Analog completes the accessories program of MTS absolute position sensors. The unit can be used for adjusting a connected 1-magnet sensor via the leads, using a simple teach-in procedure in the field.</p>
 <p>USB-Programmer R-Analog Part No. 253 134-1</p>	<p>USB-Programmer R-Analog for 1 or 2-Magnets Sensor (incl. Power supply, USB-Cable, Sensor-Cable and CD-ROM) for setting and reading of position and output values by using a PC for</p> <ul style="list-style-type: none"> - Zero/Span Magnet 1 - Zero/Span Magnet 2 - Velocity range - Free assignment of outputs to measured position or velocity - Error output value (e.g. magnet out of stroke)
 <p>USB-Programmer R-SSI Part No. 253 135-1</p>	<p>USB-Programmer R-SSI (incl. Power supply, USB-Cable, Sensor-Cable and CD-ROM) for setting and reading of</p> <ul style="list-style-type: none"> - Data length - Data format - Resolution - Measuring direction - Synchronous / asynchronous measurement - Offset, begin of the measurement range - Alarm value (Magnet outside) - Measurement filter - Differential measurement
 <p>Profibus Address-Programmer Kit for D63, D53 or cable connector Part No. 280 640</p>	<p>PROFIBUS Address Programmer is used for setting the slave address to Temposonics® sensors with Profibus-DP Interface. The setup of slave address normally is done by the profibus standard service SetSlaveAddress. Since some master systems do not support this standard, or the customer controller system can not handle it, this MTS service tool can be used for the direct setup of the sensor. The programmer and the sensor will be supplied by the included power supply.</p>

Notice: Product pictures may vary from original.

ACCESSORIES R-SERIES

Position Magnets, Floats, Connectors, Clamps, Cables and Programming Tools

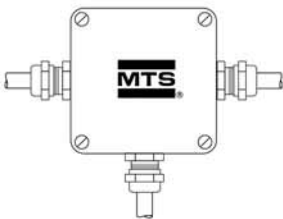
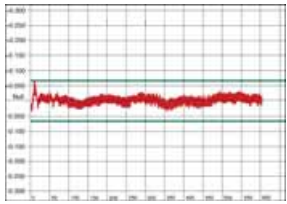
Product	Description
 <p>CANopen Address-Programmer D62 6 pin. female connector M 16 Part No. 252 382-D62 6 pin female 90°-connector M16 Part No. 252 382-D62A</p>	<p>CANopen Address Programmer is used for setting the Node-Address to Temposonics® sensors with CANopen Interface. The setup of Node-Address normally is done by the CAN Bus standard LMT-Service. Since some master systems do not support this standard, or the customer controller system can not handle it, this MTS service tool can be used for the direct setup of the sensor.</p> <p>All you need for using the programmer is a 24 VDC power supply to the sensor. The programming tool will be supplied from the Temposonics® position sensor.</p>
 <p>Profibus Master Simulator Part No. 401 727</p>	<p>PROFIBUS Master Simulator The Master Simulator can be used to check the sensors functions and to change the slave address. The magnet positions can be read out and the diagnostic data as well.</p> <p>Cable D 53 Part No. 252 383 Cable D63 Part No. 401 726</p>
 <p>Display and control unit with SSI input Part No. IX 345</p>	<p>Housing: 96 x 48 x 141 mm Cutout: 91 x 44 mm 6-segment LED Display for SSI</p>
 <p>Profibus Filter box Part No. 252 916</p>	<p>Housing: 80 x 75 x 58 mm The box is used for EMC-conformal feeding of 24 VDC supply voltage into the Profibus-DP hybrid cable.</p>
 <p>Linearity diagram Part No. 625 096</p>	<p>DIN A 4 printout with sensor data and graphic with the linearity gradient Printout with linearity gradient from the sensor. This gradient can be used to choose a special linear segment also for linearity correcture in sections.</p>

Notice: Product pictures may vary from original.

ACCESSORIES R-SERIES

ATEX [ATmosphere EXplosive]



Approved Sensors: R-Series

- Analog Output
- CAN Bus [All Versions]
- SSI Output

Note: 1. All products are available in Profile and Rod Version.
2. Signal dependent selectable with PUR, PVC or Teflon cable.

ATEX Conformity: Marking on MTS Approved Sensor

⊕ II 3G Ex nA II T4
and/or
⊕ II 3D tD A22 IP67 T100°C
TFR: 07 ATEX 027
-20°C ≤ Ta ≤ 75°C
Pmax = 4 Watt
Derated 6,5 K/W ≥ 49°C

Applicable ATEX Regulations / Directives

Directive 94/9/EG ('Manufacturers Directive')
Sets out directives for equipment manufacturers that are used in potentially explosive atmospheres.

Related Norms:

EN 60079-0:2006, EN 60079-15:2005
EN 61241-0:2006, EN 61241 - 1:2004

MTS is a certified supplier for displacement sensors intended to be used in hazardous areas of the Category 3 according to the ATEX standard.

- a. In Zone 2 (Gas, Category 3G) in the explosion groups IIA, IIB, IIC.
- b. In Zone 22 (Dust, Category 3D) at dusts with a minimum ignition energy of > 3 mJ.

Ordering Code

Temposonics® **R** **M** **1** **E X**

Model

RP- Profile

RH - Rod

Measuring Length in mm

Profile - 0050...5000 mm

Rod - 0050...7600 mm

Standard: up to 1000 in 50 mm steps, greater 1000 in 250 mm steps

Other length upon request.

Connection type:

R02 - 2 m PVC cable w/o connector, Option: R01-R10 (1-10 m)

P02 - 2 m PUR cable w/o connector, Option: P01-P10 (1-10 m)

T02 - 2 m Teflon cable w/o connector, Option: T01-T10 (1-10 m)

Note: This options are output signal dependent.

For details refer individual catalog section.

Output

Analog / CANbus / SSI

Approved Versions

ATEX

ACCESSORIES R-SERIES

Precision Position Measurement High Pressure Housing



This High Pressure Housing is ATEX EEx approved and UL and cUL approved for use in hazardous locations with Temposonics® position sensors.

The ATEX, UL and cUL approvals cover flammable gases, vapors and liquids.

This housing is made to fit Temposonics® R-Series sensors with analog and digital outputs. Both fixed cable and connector versions can be used. When using a standard sensor in this housing you get a cost efficient solution for use in hazardous locations which also allows easy sensor replacement.

Several design combinations are available to fit your application:

M18 or 3/4" UNF Mounting flange thread - M20 or 1/2" NPT Cable gland thread - long or short - top-mounted, side-mounted, or dual side-mounted cable glands. See Combination Chart.

All parts are made of 316L Stainless steel. The housing is also available in non-approved versions ensuring an outstanding protection to the sensor when used in rugged applications with high humidity and aggressive gases.

Protection Type:

ATEX:



II 2 G Ex d IIC T5 T_{amb} -40°C to +60°C

II 2 D Ex tD 20/A21 IP68 T 100°C

ITS09ATEX16296X

In accordance with EN 60079-0:2006

EN 60079-1:2007, EN 60079-26:2004,

EN 60079-0:2006 and EN 61241-1:2004

Only with ATEX approved cable glands

Class 1, Division 1, Groups A, B, C, and D

hazardous locations, temperature code T5

As to fire, electrical shock and explosion

hazards only UL certificate no. 2PD0.

In accordance with UL 1203 standard.

Only with UL approved cable glands



Material:

Stainless Steel AISI 316L (1.4404)

Cable Gland Threads:

M20 x 1,5 or 1/2" NPT

Ingress protection code:

IP68 (only with IP68 approved cable gland)

Approved sensors:

G-Series Analog + Digital

L-Series Start / Stop

R-Series Analog

R-Series Profibus

R-Series CANBUS

R-Series SSI

R-Series DeviceNet

Mounting Flange:

M18 x 1,5 or 3/4" - 16UNF - 3A

Pressure rating:

350 Bar continuous

Peak pressure:

530 Bar

Magnet type:

Ring magnets see page 58

Level Measurement:

Float on request

Top mounted cable gland

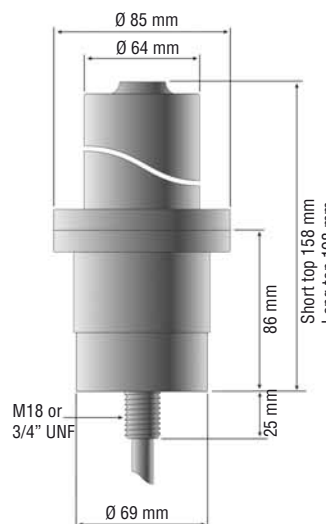

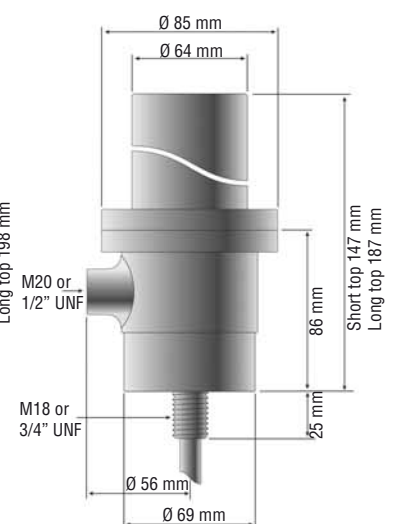

Side mounted cable gland



ACCESSORIES R-SERIES

Precision Position Measurement High Pressure Housing

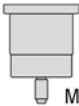
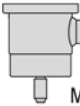
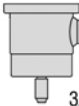
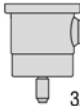
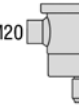
Combination Chart:

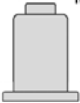
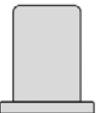
Bottom Top	 M 18	 M 20 M 18	 1/2" NPT 3/4" UNF	 1/2" NPT 3/4" UNF	 M20 M 18
Approval	ATEX	ATEX	ATEX	UL and cUL	ATEX
 M 20	0100				
		0900	1000 ATEX	1000 UL/cUL	1300
 M 20	0300				
		1700			2100

The long top is needed for Profibus sensors

Ordering Information:

Part-No. HPH -XXXX-XXXX-X-XXXXXX

Choose a design combination from the chart

Measuring length 50 - 7600 mm

Approved or Non-approved version

Only for version 1000: Please add type of approval:

- ATEX
- UL/cUL

Example: Approved short housing with M18 mounting threads and one side mounted cable gland with M20 threads and a measuring length of 650 mm:

HPH-0900-0650-A

Note!
 Accessories see data sheet "High Pressure Housing"
 Order separately: Sensor R-Series RH-B...
 B = Basic version without hydraulic rod